

# Operation and Installation Manual

---

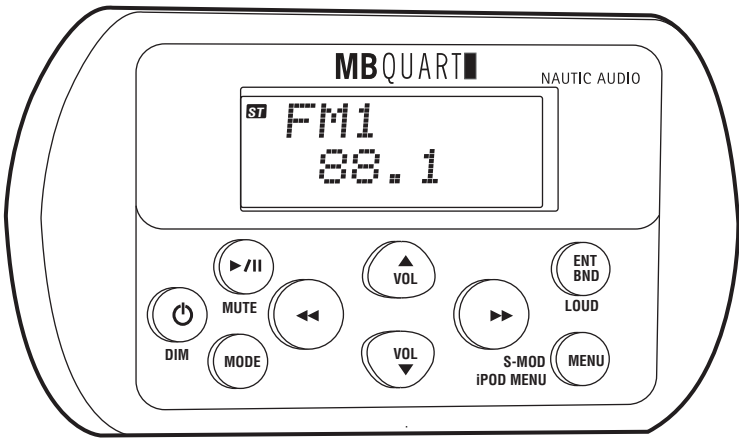

## **WRC-S2** Watertight Marine Radio Controller

## Introduction

Please take the time to read all of the information in this manual.

The WRC-S2 controls 2 different types of MB Quart systems:

- System with DVD player (Models: WM1-DVD or WM1-BB with WBB-DVD).
- System with CD player (Models: WM1-CD, WR1-CD or WM1-BB with WBB-CD).

Therefore this manual has 2 separate sections: DVD and CD. Consult your dealer to determine your type of system.

Familiarity with operation will help you obtain the best possible performance from your new Marine Radio Controller.

## Safety Information



DO NOT OPEN COVERS AND DO NOT REPAIR BY YOURSELF. PLEASE REFER SERVICING TO A QUALIFIED TECHNICIAN.

CHANGES OR MODIFICATIONS TO THIS PRODUCT NOT APPROVED BY THE MANUFACTURER WILL VOID THE WARRANTY AND WILL VIOLATE FCC APPROVAL.

## Index

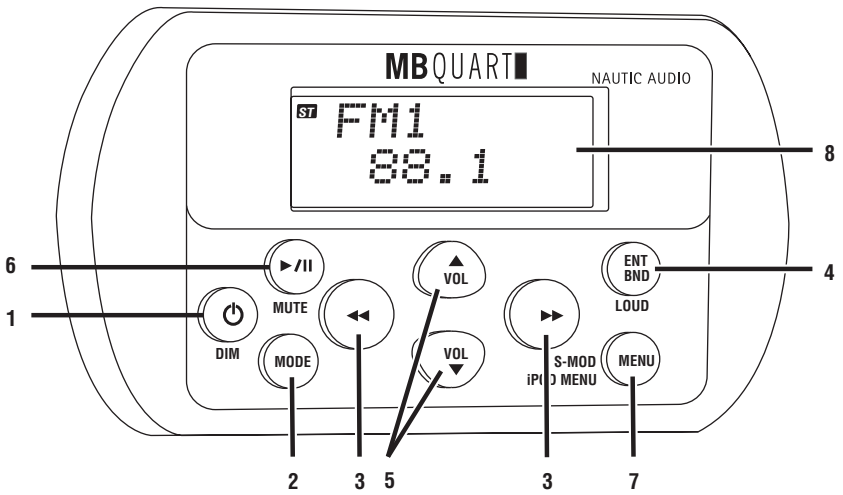
<b>DVD</b>	<b>System with DVD Player (Models: WM1-DVD or WM1-BB with WBB-DVD)</b>	
	Button Locations and Functions .....	3
	General Operation .....	4
	AM/FM Radio Operations .....	4-5
	Sound Controls .....	6
	CD Operation (Compact Disc) .....	6-7
	MP3 Disc Operation .....	7-8
	DVD Operation .....	8-9
<b>CD</b>	<b>System with CD Player (Models: WM1-CD, WR1-CD or WM1-BB with WBB-CD)</b>	
	Button Locations and Functions .....	10
	General Operation .....	11
	AM/FM Radio Operations .....	11-12
	Sound Controls .....	13
	CD Operation (Compact Disc) .....	13-14
	MP3 Disc Operation .....	14-15
	CD Changer Operation .....	15-16
	Sirius	
	Sirius Satellite Radio Setup .....	16
	Sirius Satellite Radio Operation .....	17-18
	IPOD Operation .....	18-20
	USB Operation .....	20
	Auxiliary Audio Input Operation .....	21
	Installation .....	22
	Warranty .....	23



1. **Power On/Off and Display Dimmer:** Press to turn the unit on or off. Press and hold to dim the display. Press and hold again to restore display's illumination.
2. **Mode Button:** Press to change the play source: Radio, DVD, Audio/Video Input and Auxiliary Audio Input. Depending on what other input sources are connected (IPOD, Sirius, USB and CD Changer) these play source will also appear in the display.
3. **Tune/Track Buttons:**  
**Radio Mode:** Press either button and the tuner will scan to the next strong station and stop. Then press and hold either button until "MANUAL" appears in the display then release. Again press either button until the desired radio station appears in the display.  
**CD and CD Changer Mode:** Press to change the track to a lower or higher track.
4. **Enter/Band and Loud Button (ENT BND):**  
**Radio:** Press to select AM1, AM2, FM1, FM2 and FM3 radio bands.  
**Loudness:** Press and hold button until "LOUD ON" appears in the display to boost high and low tones at low volume levels. To deactivate press and hold again until "LOUD OFF" appears in the display.  
**IPOD Mode:** See IPOD Operation Section for more information.
5. **Volume Control:** Press the  button to increase the volume level and press the  button to decrease the volume level.
6. **DVD/CD Play/Pause and Mute Button:**  
**DVD/CD and CD Changer Mode:** Press to pause disc play, press again to resume play.  
**Radio, Sirius Satellite Radio and AUX Input Modes:** Press to mute volume level. Press again to restore.
7. **Menu Button:**  
**Sirius Mode:** See Sirius Satellite Radio Operation section for more information.  
**IPOD Mode:** See IPOD Operation section for more information.
8. **Display Area:** This area displays all function information for the radio, DVD/CD player, auxiliary and IPOD modes.

## DVD General Operations

### Power On/Off:

Press the  button to turn the unit on or off.

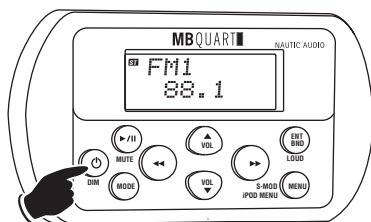

### Selecting a Play Source:

To select a play source, press the **MODE** button until the desired source appears in the display:

**AM1, AM2, FM1, FM2 or FM3** (AM and FM Radio),

**Note:** Radio station call letter may be displayed instead of the radio band.

**SIRIUS** (Satellite Radio Input, if connected),

**DVD PLAY** (DVD Player),

**USB PLAY** (MP3 Player, if connected),

**IPOD** (IPOD Input, if connected)

**CD-CH** (CD Changer, if connected),

**AUX IN** (Auxiliary Audio Input, if connected) and

**AV IN** (Auxiliary Audio/Video Input)

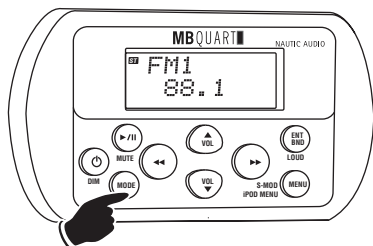

### Dimming the Display:

Press and hold the  button to dim the brightness of the display. Press and hold again to restore the brightness of display.

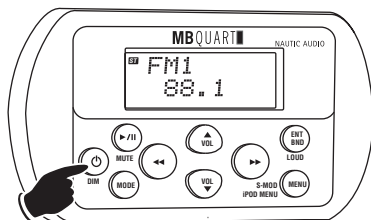

**Hold**

## DVD AM/FM Radio Operation

### Power On/Off:

Press the  button to turn the unit on.

### Selecting the Play Source:

Press the **MODE** button until "AM1, AM2, FM1, FM2 or FM3" appears in the display.

**Note:** Radio station call letter may be displayed instead of the radio band.

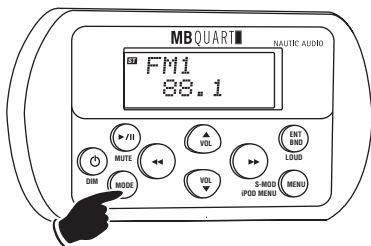

## Selecting the AM or FM Band:

Press the **ENT BND** button repeatedly and select from FM1, FM2, FM3, AM1 or AM2.

**Note:** Radio station call letter may be displayed instead of the radio band.

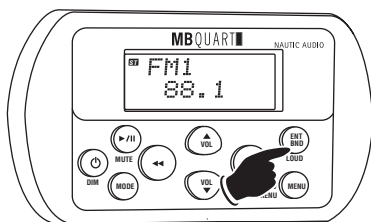

## Manually Tuning in a Radio Station:

Press and hold either the **◀** or **▶** button until "MANUAL" appears in the display then release.

Then press the **◀** or **▶** until the desired radio station appears in the display.

**Note:** The unit will automatically switch from FM Mono to FM Stereo when the signal strength increases to a stereo level. If the stereo signal should become weak, the unit will switch back to Mono. FM stereo reception is indicated when the "ST" appears in the display.

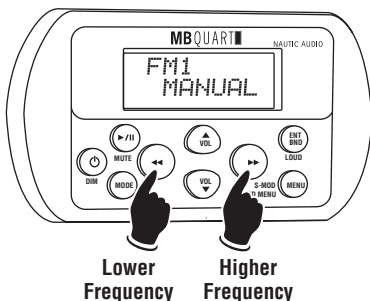

## Tuning in a Radio Station Using Seek:

Press and release either the **◀** or **▶** button and the tuner will scan up to the next strong station and stop seeking and start playing.

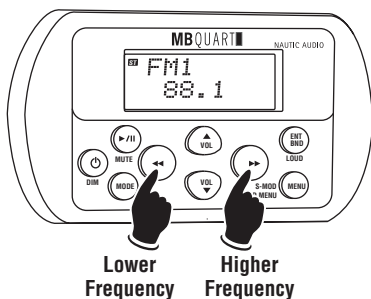

## Scanning for FM Radio Stations According to Program Type (PTY):

1. Press the **ENT BND** button to select either the FM1, FM2 or FM3 radio band.
2. Press the **MENU** button to display the program type.
3. Press the **▲VOL** or **▼VOL** to select the desired program type (PTY). (Example: News, Information, Sports, etc.)
4. Press the **◀** or **▶** button to search a station with the selected program type (PTY).

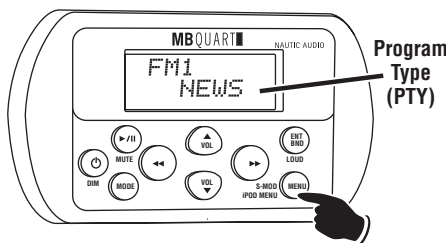

## DVD Sound Controls

### Volume:

Increase the volume by pressing the  button.

Decrease the volume by pressing the  button.

Increase

Decrease

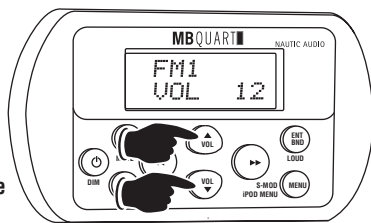

### Loudness:

To boost high and low tones at low volume levels, press and hold the **ENT BND** button until "LOUD ON" appears in the display. To deselect, press and hold the **ENT BND** button again until "LOUD OFF" appears in the display.

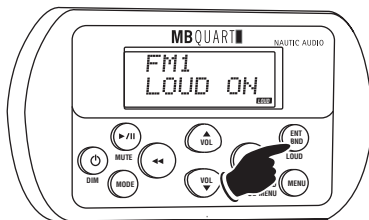

### Mute:

Press and release the **MUTE** button to mute the volume level. If a CD is playing the **MUTE** button will pause the disc. Press the **MUTE** button again to restore the volume or resume playing the disc.

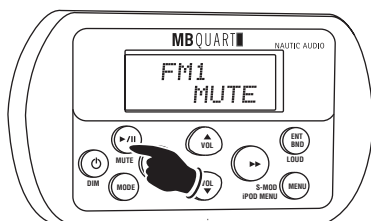

## DVD CD Operation

### Power On/Off:

Press the  button to turn the unit on.

### Load CD Disc into DVD Player:

The unit will automatically switch to the "DVD PLAY" mode and start playing the CD.

### Selecting the Play Source when the CD is Already Loaded:

Press the **MODE** button until "DVD PLAY" appears in the display.

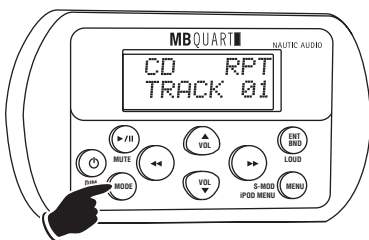

## DVD CD Operation (Continued)

### CD Track Selection:

Press the ◀ button to select a lower track.  
Press the ▶ button to select a higher track.  
The track number will appear in the display.

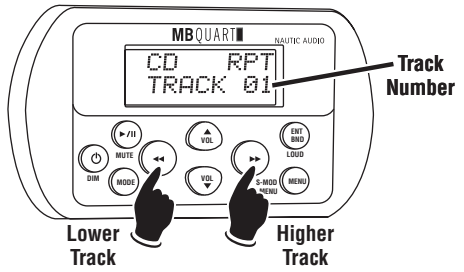

### Pausing a CD:

Press the ⏸ button to pause the disc, press it again to resume play.

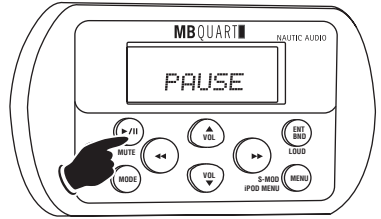

## DVD MP3 Operation

### Power On/Off:

Press the ⏻ button to turn the unit on.

### Load MP3 Disc into DVD Player:

The unit will automatically switch to the "DVD PLAY" mode and start playing the MP3 disc.

### Selecting the Play Source when the MP3 Disc is Already Loaded:

Press the **MODE** button until "DVD PLAY" appears in the display.

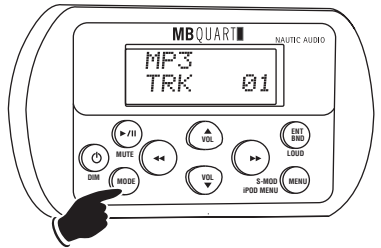

### MP3 Track Selection:

Press the ◀ button to select a lower track.  
Press the ▶ button to select a higher track.  
The track number will appear in the display.

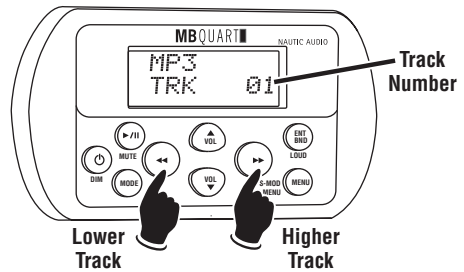

## DVD MP3 Operation (Continued)

### Pausing a Disc:

Press the  button to pause the disc, press it again to resume play.

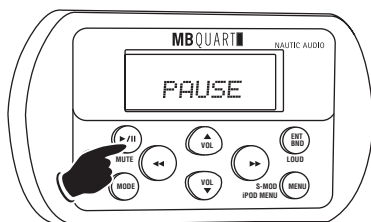

## DVD DVD Operation

### Power On/Off:

Press the  button to turn the unit on.

### Load CD Disc into DVD Player:

The unit will automatically switch to the "DVD PLAY" mode and start playing the CD.

### Selecting the Play Source when the CD is Already Loaded:

Press the **MODE** button until "DVD PLAY" appears in the display.

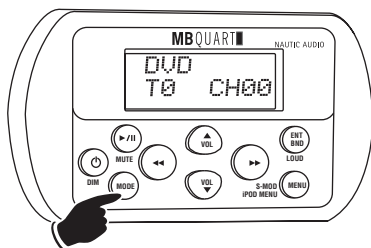

### Playing a DVD:

Press the  button to play the disc.

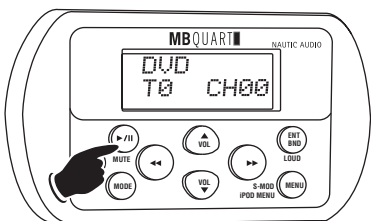

### Pausing a DVD:

Press the  button to pause the disc, press it again to resume play.

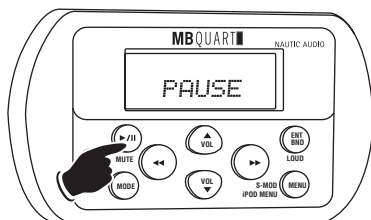

## DVD DVD Operation (Continued)

### DVD Chapter Selection:

Press the ◀ button to select a lower chapter.  
Press the ▶ button to select a higher chapter.  
The chapter number will appear in the display.

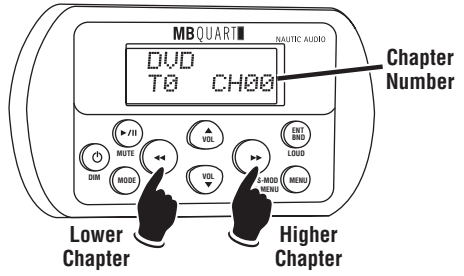

### Fast Forward / Fast Reverse Disc Play:

Press and hold the ◀ (fast forward) or ▶ (fast reverse) button during play. Each time the button is pressed and held, the speed of fast forward/fast reverse changes in the following order:  
2X, 4X, 8X, 20X  
To resume normal play, press the ▶|| button.

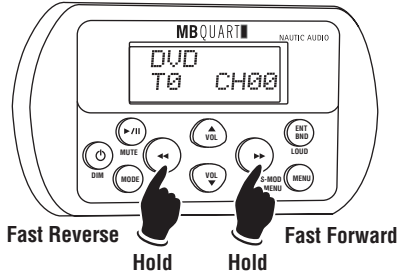

### DVD Setup Menu:

Press the MENU button to display the DVD Setup Menu. Use the VOL, ◀ or ▶ buttons to navigate Setup Menu. Make a selection by pressing the ENT BND button.

**Note:** To access the DVD Setup Menu a DVD disc has to be inserted.

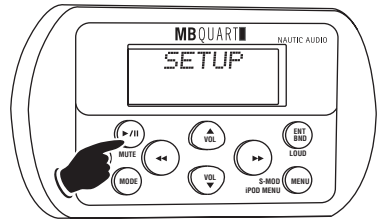

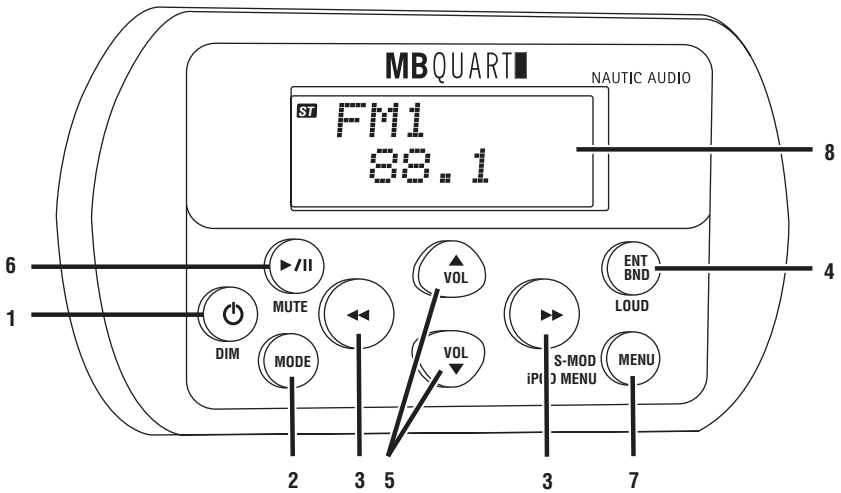

- 1. Power On/Off and Display Dimmer:** Press to turn the unit on or off. Press and hold to dim the display. Press and hold again to restore display's illumination.
- 2. Mode Button:** Press to change the play source: Radio, CD and .Auxiliary Audio Input. Depending on what other input sources are connected (IPOD, Sirius, USB and CD Changer) these play source will also appear in the display.
- 3. Tune/Track Buttons:**

**Radio Mode:** Press either button and the tuner will scan to the next strong station and stop. Then press and hold either button until "MANUAL" appears in the display then release. Again press either button until the desired radio station appears in the display.

**CD and CD Changer Mode:** Press to change the track to a lower or higher track.
- 4. Enter/Band and Loud Button (ENT BND):**

**Radio:** Press to select AM1, AM2, FM1, FM2 and FM3 radio bands.

**Loudness:** Press and hold button until "LOUD ON" appears in the display to boost high and low tones at low volume levels. To deactivate press and hold again until "LOUD OFF" appears in the display.

**IPOD Mode:** See IPOD Operation Section for more information.
- 5. Volume Control:** Press the button to increase the volume level and press the button to decrease the volume level.
- 6. CD Play/Pause and Mute Button:**

**CD and CD Changer Mode:** Press to pause disc play, press again to resume play.

**Radio, Sirius Satellite Radio and AUX Input Modes:** Press to mute volume level. Press again to restore.
- 7. Menu Button:**

**Sirius Mode:** See Sirius Satellite Radio Operation section for more information.

**IPOD Mode:** See IPOD Operation section for more information.
- 8. Display Area:** This area displays all function information for the radio, CD player, auxiliary and IPOD modes.

**Power On/Off:**

Press the  button to turn the unit on or off.

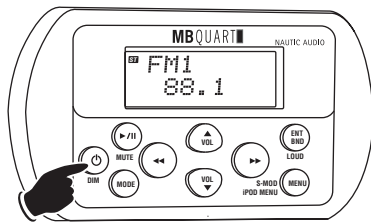
**Selecting a Play Source:**

To select a play source, press the **MODE** button until the desired source appears in the display:

**AM1, AM2, FM1, FM2 or FM3** (AM and FM Radio),

**Note:** Radio station call letter may be displayed instead of the radio band.

**SIRIUS** (Satellite Radio Input, if connected),

**CD** (CD Player),

**CD-CH** (CD Changer, if connected),

**AUX1 IN** (Auxiliary Audio Input, if connected),

**AUX2 IN** (Auxiliary Audio Input, if connected),

**IPOD** (IPOD Input, if connected) and

**USB** (MP3 Player, if connected)

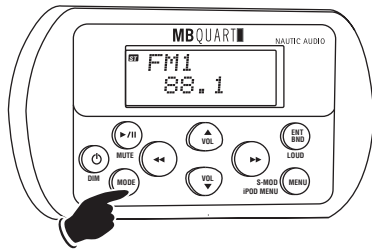
**Dimming the Display:**

Press and hold the  button to dim the brightness of the display. Press and hold again to restore the brightness of display.

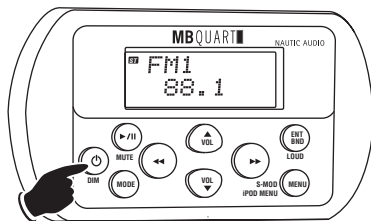

**Hold**

**Power On/Off:**

Press the  button to turn the unit on.

**Selecting the Play Source:**

Press the **MODE** button until "AM1, AM2, FM1, FM2 or FM3" appears in the display.

**Note:** Radio station call letter may be displayed instead of the radio band.

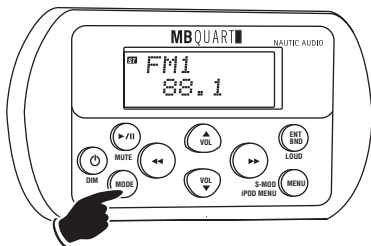

**Selecting the AM or FM Band:**

Press the **ENT BND** button repeatedly and select from FM1, FM2, FM3, AM1 or AM2.

**Note:** Radio station call letter may be displayed instead of the radio band.

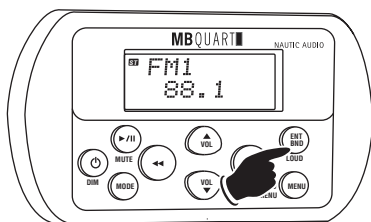
**Manually Tuning in a Radio Station:**

Press and hold either the **◀◀** or **▶▶** button until "MANUAL" appears in the display then release. Then press the **◀◀** or **▶▶** until the desired radio station appears in the display.

**Note:** The unit will automatically switch from FM Mono to FM Stereo when the signal strength increases to a stereo level. If the stereo signal should become weak, the unit will switch back to Mono. FM stereo reception is indicated when the "ST" appears in the display.

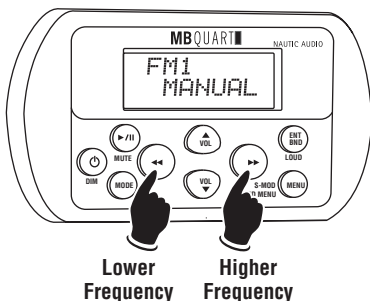
**Tuning in a Radio Station Using Seek:**

Press and release either the **◀◀** or **▶▶** button and the tuner will scan up to the next strong station and stop seeking and start playing.

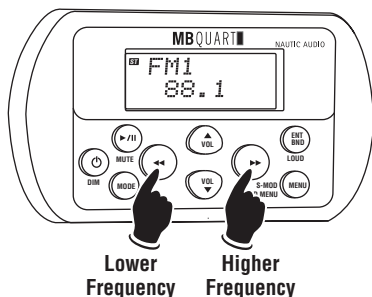
**Scanning for FM Radio Stations According to Program Type (PTY):** (Only available on specific models)

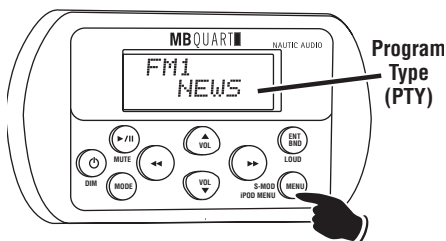

1. Press the **ENT BND** button to select either the FM1, FM2 or FM3 radio band.
2. Press the **MENU** button to display the program type.
3. Press the **VOL** or **VOL** to select the desired program type (PTY). (Example: News, Information, Sports, etc.)
4. Press the **◀◀** or **▶▶** button to search a station with the selected program type (PTY).



## CD

## Sound Controls

### Volume:

Increase the volume by pressing the  button.  
Decrease the volume by pressing the  button.

Increase

Decrease

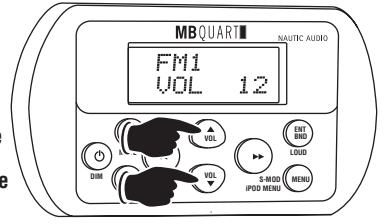

### Loudness:

To boost high and low tones at low volume levels, press and hold the **ENT BND** button until "LOUD ON" appears in the display. To deselect, press and hold the **ENT BND** button again until "LOUD OFF" appears in the display.

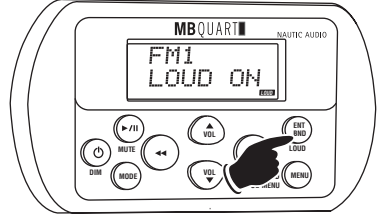

### Mute:

Press and release the **MUTE** button to mute the volume level. If a CD is playing the **MUTE** button will pause the disc. Press the **MUTE** button again to restore the volume or resume playing the disc.

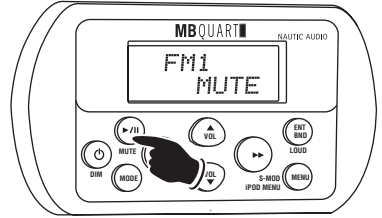

## CD

## CD Operation

### Power On/Off:

Press the  button to turn the unit on.

### Load CD Disc into CD Player:

The unit will automatically switch to the "CD" mode and start playing the CD.

### Selecting the Play Source when the CD is Already Loaded:

Press the **MODE** button until "CD" appears in the display.

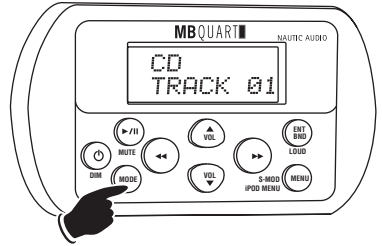

## CD

## CD Operation (Continued)

### CD Track Selection:

- Press the ◀ button to select a lower track.
- Press the ▶ button to select a higher track.
- The track number will appear in the display.

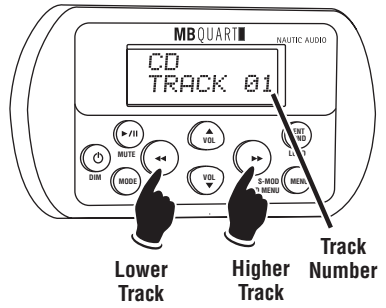

### Pausing a CD:

- Press the ⏸ button to pause the disc, press it again to resume play.

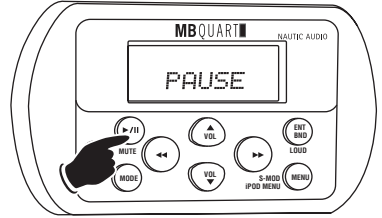

## CD

## MP3 Operation

### Power On/Off:

- Press the ⏻ button to turn the unit on.

### Load MP3 Disc into DVD Player:

- The unit will automatically switch to the "CD" mode and start playing the MP3 disc.

### Selecting the Play Source when the MP3 Disc is Already Loaded:

- Press the **MODE** button until "CD" appears in the display.

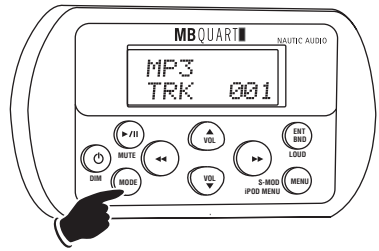

### MP3 Track Selection:

- Press the ◀ button to select a lower track.
- Press the ▶ button to select a higher track.
- The track number will appear in the display.

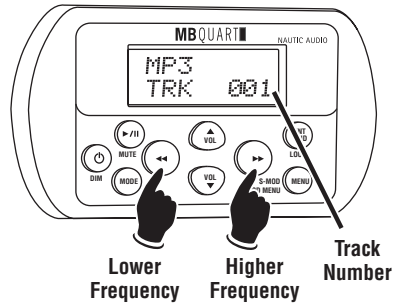

**Pausing a Disc:**

Press the  button to pause the disc, press it again to resume play.

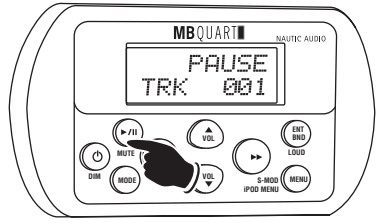
**CD Changer Operation (Option)****Power On/Off:**

Press the  button to turn the unit on.

**Load CD's into Changer:**

Insert the CD magazine into the external CD changer.

**Selecting the Play Source:**

Press the **MODE** button until "CD-CH" appears in the display.

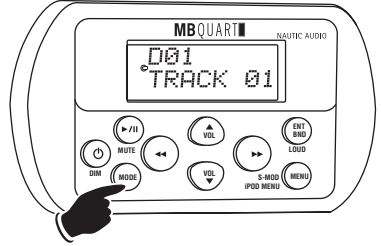

**CD Track Selection:**

Press the  button to select a lower track.

Press the  button to select a higher track.

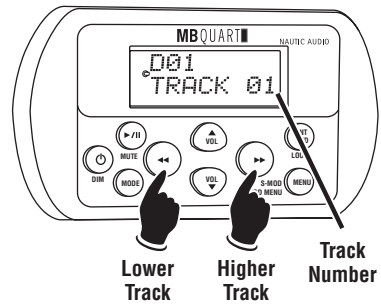
The track number will appear in the display.

**CD Disc Selection:**

1. Press the **MENU** button and "DISC SEL" appears in the display.
2. Press the  or  button to select the desired disc. The selected disc will appear in the display.

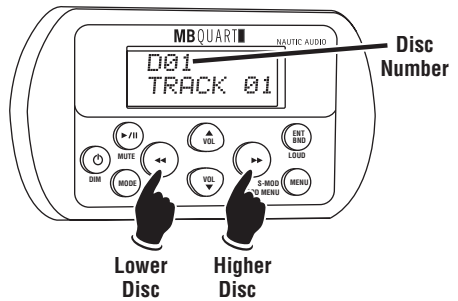

## CD Changer Operation (Option) (Continued)

### Pausing a CD:

Press the  button to pause the disc, press it again to resume play.

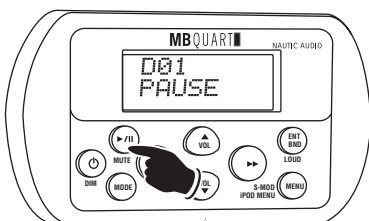

## Sirius Satellite Radio Setup (Option)

**Note:** If your Sirius tuner is not activated, call 1-888-539-SIRIUS to activate. The Sirius Tuner ID Number (ESN) is required during the activation process. Following the instructions below to access the Sirius Tuner ID Number (ESN):

### Accessing your Sirius Tuner ID Number (ESN):

1. Press the **MODE** button until "SIRIUS" appears in the display area.

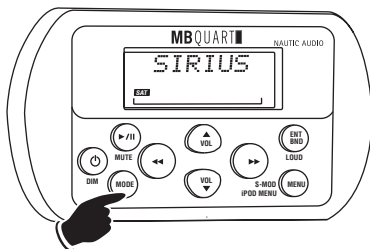

2. Press the **MENU** button until "DIR" appears in the display area.

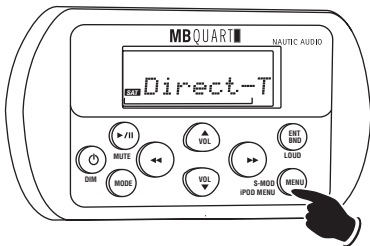

3. Press the **ENT BND** button until "ESN = 00.." appears in the display area. The ESN number will scroll across the display.

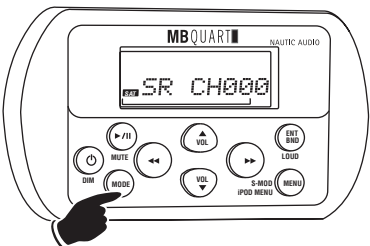

4. Press the **ENT BND** button again to exit.

4 Times

## Sirius Satellite Radio Operation (Option)

Please note that satellite radio signal may be blocked by trees, buildings, bridges or tunnels.

### Information display during reception:

**ANTENNA ERROR:** When an antenna issue exists.

**ACQUIRING SIGNAL:** When a channel is being tuned in (no signal is yet received).

**INVALID CHANNEL:** A channel without a broadcast has been selected, or the receiver may not be activated.

**CALL 888-539-SIRIUS TO SUBSCRIBE:** A channel not covered by your contract or the Sirius tuner is not activated. Call Sirius Service Center 1-888-539-SIRIUS (7474), or visit them online at [www.siriusradio.com](http://www.siriusradio.com).

### Channel Selection Modes:

Channels are selected by the following methods:

- Manual Tuning: (Use the Manual Tuning method to scan thru the channels)
- Direct Tuning: (Use the Direct Tuning methods when you know the desired channel)
- Category Tuning: (Use the Category Tuning method when you know what category you want to scan for a channel, feature not available with this controller)

For details, see the following operation descriptions:

#### Manual Tuning:

Press the ◀ or ▶ button until the desired channel appears in the display.

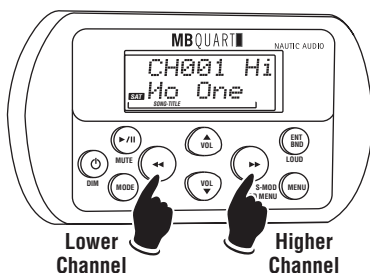

#### Direct Tuning:

1. Press the MENU button until "Direct-T" appears in the display.

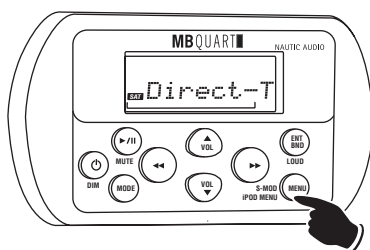

2. Press the ◀ or ▶ button to select the first number of the desired channel.

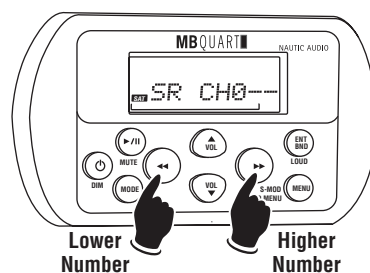

## Sirius Satellite Radio Operation (Option) (Continued)

3. Press the **MENU** button to select the next number of the channel. Use the **◀** or **▶** buttons to select the desired number. Repeat this procedure for the third number.

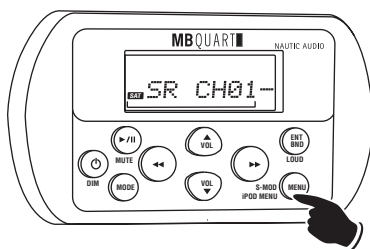

4. Press the **ENT BND** button and the channel will start playing.

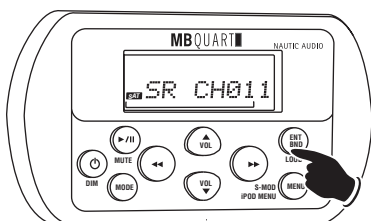

## IPOD Operation

### General Operations:

1. Press the **⏻** button to turn the unit on.
2. Connect an IPOD to the cable attached to the radio.
3. The unit will automatically switch to the IPOD mode and start playing.

**Note:** The IPOD controls will become inoperable and the radio will now control the IPOD.

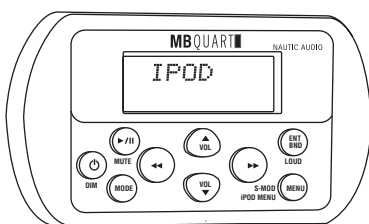

### IPOD Button Location and Functions:

1. **Menu Button:** Same operation as the MENU button on an IPOD.
2. **Next and Previous Button:** Press these buttons to scroll through the menu items, same operation as the IPOD's Click Wheel.
3. **Play/Pause Button (▶||):** Same operation as the ▶|| button on an IPOD.
4. **ENT BND Button:** Same operation as the Center Select button on an IPOD.

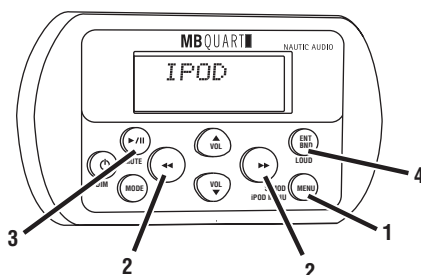

## IPOD Operation (Continued)

### Browse for a Song:

1. Press the **MENU** button and either "PLAYLIST, ARTIST, ALBUM GENRE, SONGS or COM-POSER" appears in the display.

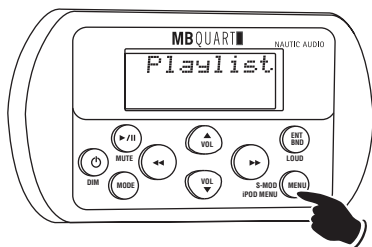

2. Press the ◀▶ or ▶▶ button to select the SONGS menu.

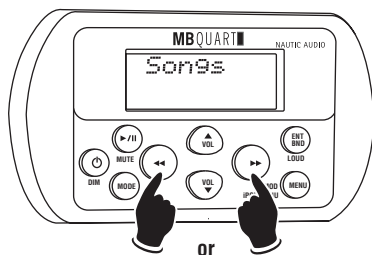

3. Slowly press the **ENT BND** button twice to select the SONGS menu.

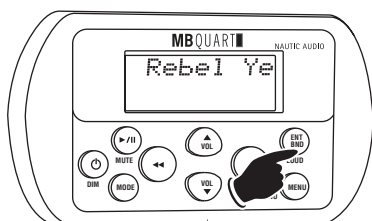

4. Press the ▶▶ button to select the desired song from the menu. Once the ▶▶ button has been used to scroll into the song list the ◀▶ button can be used to scroll backwards.

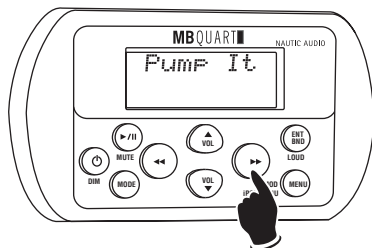

5. Press the **ENT BND** button to start playing the selected song.

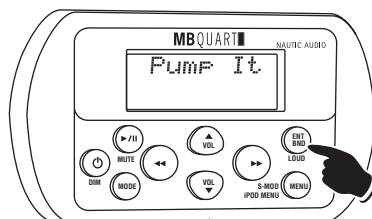

## IPOD Operation (Continued)

### Pausing a Track:

Press the  button to pause the track, press it again to resume play.

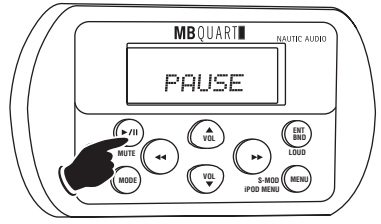

## USB Operation (Only available on specific models)



### General Operations:

1. Press the  button to turn the unit On.
2. Connect a MP3 player to the USB socket.
3. The unit will automatically switch to the "USB PLAY" mode and start playing.

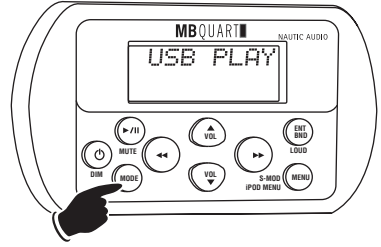
**Note:** The controls on the MP3 player will become inoperable and the MB Quart system will now control the MP3 player.



### Track Selection:

Press the  button to select a lower track.  
Press the  button to select a higher track.  
The track number will appear in the display.

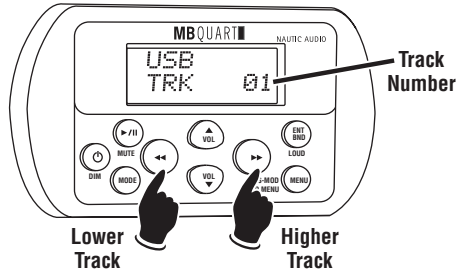

### Pausing a Track:

Press the  button to pause the track, press it again to resume play.

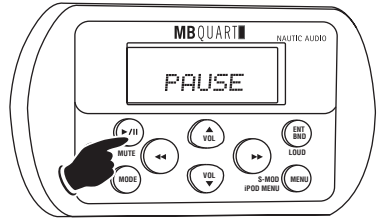

## Auxiliary Audio Input Operation

### Selecting an Audio Play Source:

1. Press the  button to turn the unit On.
2. Press the **MODE** button until "AUX1 IN, AUX2 IN or AV IN" appears in the display.
3. Refer to the audio device's owners manual for proper operation.

**Note:** The MB Quart system will not control the auxiliary source but the sound controls can be adjusted.

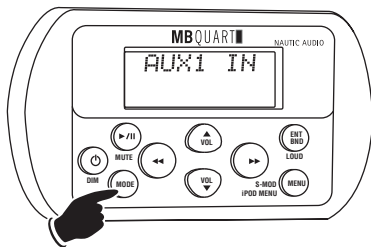

# Installation

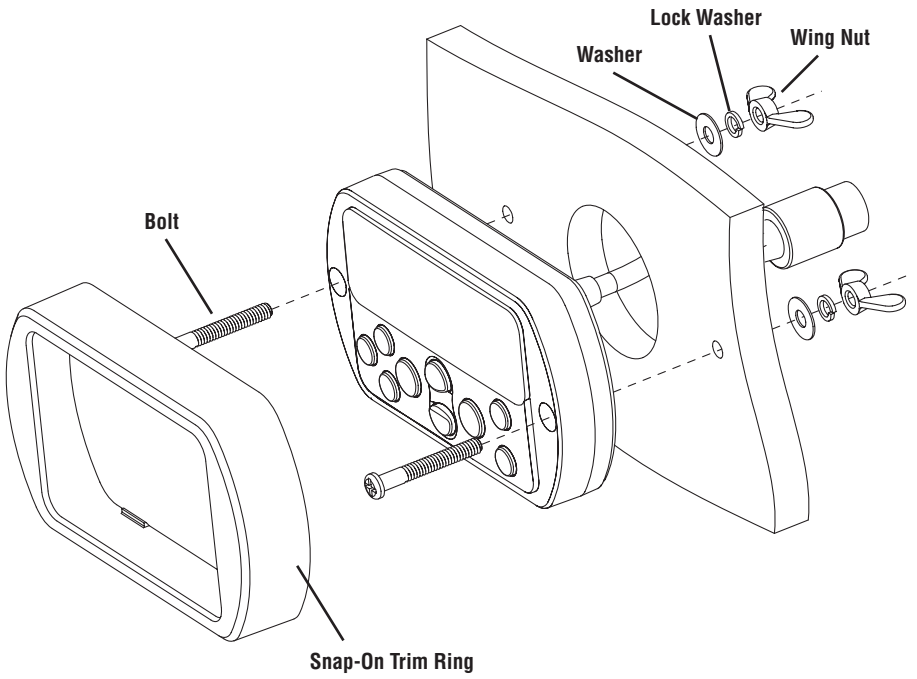
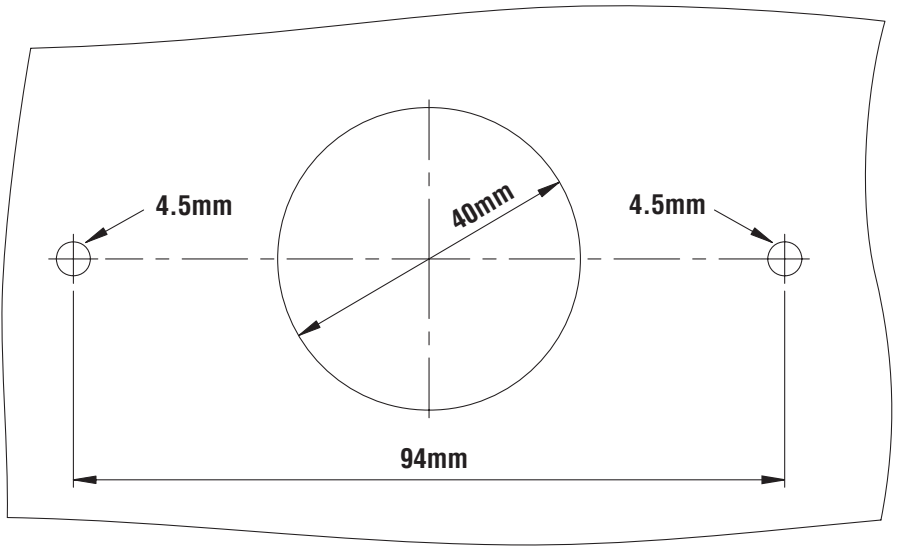

# MBQUART

## NAUTIC AUDIO

### LIMITED WARRANTY

This warranty will be honored only in U.S.A.

MB Quart offers to the original purchaser a one (1) year warranty period from date of purchase. Except as specified below, this warranty covers all defects in material and workmanship in this component. The following are not covered by the warranty:

1. Any product which is not distributed in the U.S.A. by TriStar Distributing or which is not purchased in the U.S.A. from an authorized TriStar Distributing dealer.
2. Any product on which the serial has been defaced, modified or removed,
3. Damage, deterioration or malfunction resulting from:
  - a. Any shipping damage (claims must be presented to the carrier).
  - b. Installation or removal of the product.
  - c. Accident, acts of nature, misuse, abuse, neglect, unauthorized product modification or failure to follow instructions supplied with the product.
  - d. Repair or attempted repair by anyone not authorized by TriStar Distributing.
  - e. Any other cause that does not relate to a product defect.

If within the one-year warranty period your MB Quart marine product should fail, please contact the dealer where the product was purchased to obtain authorization for warranty service. You must include a copy of the original dated sales receipt as proof of warranty coverage. All warranty service returns must be shipped freight prepaid. We will pay the return shipping charges, if repairs are covered by the warranty and we are shipping within the United States.

After the warranty period if your MB Quart Marine Product ever needs service, please call 1-800-621-2278 and ask for the service department, to determine if the repairs are feasible.

#### LIMITATION OF IMPLIED WARRANTIES

ALL IMPLIED WARRANTIES, INCLUDING WARRANTIES OF MERCHANTABILITY AND FITNESS FOR A PARTICULAR PURPOSE, ARE LIMITED IN DURATION TO THE LENGTH OF THIS WARRANTY.

#### EXCLUSION OF DAMAGES

TriStar Distributing liability for any defective product is limited to the repair or replacement of the product at our discretion. TriStar Distributing shall not be liable for:

1. Installation or removal, damage to other property caused by any defects in components, damages based upon inconvenience, loss of use of the product; or any other damages, whether incidental, consequential or otherwise.
2. Some states do not allow limitations on how long an implied warranty lasts and/or do not allow the exclusion or limitation of incidental or consequential damages, so the above limitations and exclusions may not apply to you.

This warranty gives you specific rights, and you may have other rights, which may vary from state to state.

If a problem develops during or after the Limited Warranty Period; or if you have any questions regarding the operation of the product, you should contact TriStar Distributing warranty department.

TriStar Distributing  
58263 Charlotte Avenue  
Elkhart, Indiana 46517  
800-621-2278

